

Quick Start Guide

GV-Video Server



Thank you for purchasing GV-Video Server. This guide is designed to assist new users in getting immediate results from the GV-Video Server. For advanced information on how to use the GV-Video Server, please refer to GV-Video Server User's Manual on GeoVision download page: <http://www.geovision.com.tw/download/product/>.

1 Introduction

Welcome to the GV-Video Server Quick Start Guide. In the following sections, you will learn about the basic installations and configurations of GV-Video Server (GV-VS04H / 11 / 12 / 14 / 2420 / 2400 / 2401 / 2800 / 2820 / 21600). For details, see GV-Video Server User's Manual on the GeoVision download page: <http://www.geovision.com.tw/download/product/>.

Packing List

GV-VS04H / 14

- GV-VS04H / GV-VS14
- 3.5 mm Stereo to RCA Cable x 2
- DC Male-to-Male Cable



- AC Power Cord
- Conical Anchor x 4
- Screw x 4
- GV-Video Server Software CD/DVD
- GV-NVR Software CD/DVD
- Power Adaptor
- Wall Hook

Note: The DC Male-to-Male Cable is used to power the camera through the GV-Video Server. You can also optionally purchase three more DC Male-to-Male Cables and one DC 1-Male to 4-Female Cable to power four cameras through the GV-Video Server.



DC 1-Male to 4-Female Cable

DC Male-to-Male Cable

GV-VS11

- GV-VS11
- Power Adaptor
- GV-Video Server Software CD/DVD
- GV-NVR Software CD/DVD

GV-VS12

- GV-VS12
- I/O Cable with RJ-45 Connector



- Sticker (for positioning conical anchors)
- AC Power Cord
- Power Adaptor
- Wall Hook
- Screw x 4
- Conical Anchor x 4
- GV-Video Server Software CD/DVD
- GV-NVR Software CD/DVD

GV-VS2420 / 2400

- GV-VS2420 / 2400
- AC Power Cord
- Power Adaptor
- Download Guide
- Warranty Card

GV-VS2401

- [GV-VS2401](#)
- [AC Power Cord](#)
- [Power Adaptor](#)
- [Download Guide](#)
- [Warranty Card](#)

GV-VS2800 / 2820

- [GV-VS2800 / 2820](#)
- [AC Power Cord](#)
- [Power Adaptor](#)
- [Download Guide](#)
- [Warranty Card](#)

GV-VS21600

- [GV-VS21600](#)
- [AC Power Cord](#)
- [Power Adaptor](#)
- [DVI to 16 Video BNC Breakout Cable](#)
- [DVI to 16 Audio RCA Breakout Cable](#)
- [Download Guide](#)
- [Warranty Card](#)

Options

Optional devices can expand your GV-Video Server's capabilities and versatility. Contact your dealer for more information.

GV-GPS Receiver	GV-GPS Receiver is a Global Position System receiver. With the GV-GPS Receiver, you can perform GPS tracking and location verification of the GV-Video Server. Two types of interfaces are available: UART (for GV-VS04H / 14) and RS-232 (for GV-VS12).
-----------------	--

Note: GV-GPS Receiver is only supported by GV-VS04H / 12 / 14.

GV-Relay V2	Working with a GV-Relay V2, the GV-Video Server is capable of driving the loads of relay outputs over 5 volts.
-------------	--

GV-WiFi Adaptor V2	Only supported by GV-VS2420 / 2400 (Firmware Version 1.03 or later) / 2401 / 2820 / 2800 / 21600. The WiFi Adaptor V2 is designed to connect GV IP devices, such as GV-Video Server, to the wireless network.
--------------------	---

GV-PA191 PoE Adaptor	GV-PA191 is designed to provide power to the IP device through a single Ethernet cable. GV-PA191 is only supported by GV-VS04H / 12.
----------------------	--

GV-VR605A DC Voltage Regulator	With a GV-VR605A, you can install the GV-Video Server in the car. GV-VR605A will supply and maintain a 12V voltage to the GV-Video Server and its connected cameras.
--------------------------------	--

Note: GV-VR605A is only supported by GV-VS04H / 11 / 12 / 14.

DC Male-to-Male Cable / DC 1-Male to 4-Female Cable	Only available for GV-VS2420 / 2400 / 2401, the DC Male-to-Male Cable is used to power the camera through the GV-Video Server. For instance, you can purchase four DC Male-to-Male Cables and one DC-1-Male to 4-Female Cable to power four cameras through the GV-Video Server.
--	---

3.5 mm Stereo to RCA Cable	Only supported by GV-VS2401 / 2800 / 2820, the 3.5 mm Stereo to RCA Cable is served as an audio adapter for microphones with RCA connectors.
----------------------------	--

Wall Hook Only supported by GV-VS2420 / 2400 / 2401 / 2800 / 2820 / 21600, the Wall Hook is used to mount the device to the wall.

Din-rail Hook Only supported by GV-VS2420 / 2400 / 2401 / 2800 / 2820 / 21600, the Din-rail Hook is used to mount the device to a 35-mm (1.38-in) DIN rail.

Rack Mount Only supported by GV-VS2420 / 2400 / 2401 / 2800 / 2820 / 21600, the Rack Mount is used to mount up to 3 GV-VS2420 / 2400 / 2401 or 2 GV-VS2800 / 2820 / 21600 video servers to a 19-inch (482.6-mm) rack.

Access Control Series

GV-Video Server can work with the Wiegand-interface card reader to send cardholder data to central monitoring stations, such as Center V2 and VSM, as well as GV-DVR / NVR. The following devices are only supported by GV-VS04H / 14.

GV-Reader GV-Reader includes transmit-receive antenna and electronics. Featured with both Wiegand and RS-485 outputs, the unit is compatible with any standard access control panel.

GV-R1352 Card Reader GV-R1352 is a card reader designed to recognize identification cards. Featured with the Wiegand and RS-485 outputs, the unit can be connected to any standard access control panel. GV-R1352 comes with a weather-sealed and IP66 compliant housing for outdoor use.

GV-VS04H / 14

Front View

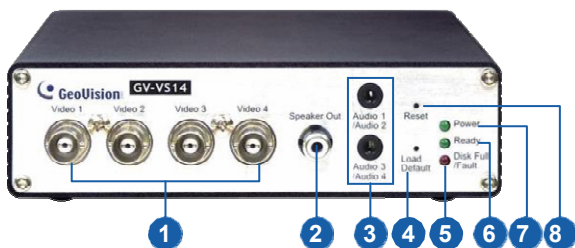

Rear View

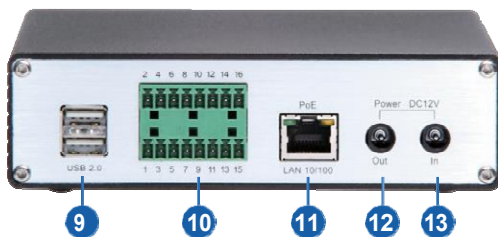

No.	Name	Function
1	Video Input	4 plugs for video inputs.
2	Speaker Output	A plug for the speaker device.
3	Audio Input	Each plug is for 2 audio inputs.
4	Default Button	It resets all configurations to their factory settings. See <i>7 Restoring to Default Settings</i> in the <i>Quick Start Guide</i> .
5	Disk Full/Fault LED	This LED is on, indicating the hard drive is full or faulty.
6	Ready LED	This LED is on, indicating the GV-Video Server is ready for connection.
7	Power LED	This LED is on, indicating the power is supplied.
8	Reset	It reboots the GV-Video Server, and keeps all current configurations.
9	USB Port	2 USB ports for installing portable storage devices.
10	Terminal Block	The connectors for digital inputs, relay outputs, PTZ cameras, Wiegand device and GPS module control.
11	Ethernet Port	A plug for a 10/100 Ethernet or PoE.
12	Power Out	<p>Note: GV-VS14 does not support PoE function.</p> <p>A plug to power the camera, by using a DC Male-to-Male Cable, directly through the GV-Video Server.</p> <p>Note: When PoE is applied, you cannot power the camera through the GV-Video Server.</p>
13	Power In	A plug to power the GV-Video Server.

GV-VS11

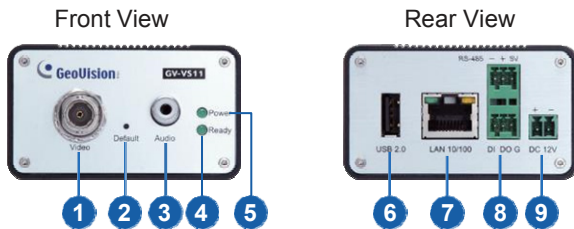

No.	Name	Function
1	Video Input	1 plug for video input.
2	Default Button	It resets all configurations to their factory settings. See <i>7 Restoring to Default Settings</i> in the <i>Quick Start Guide</i> .
3	Audio Input	1 plug for audio input.
4	Ready LED	This LED is on, indicating the GV-Video Server is ready for connection.
5	Power LED	This LED is on, indicating the power is supplied.
6	USB Port	1 USB port for installing portable storage device.
7	Ethernet Port	A plug for inserting an Ethernet cable to build the network connection.
8	Terminal Block	The connectors for digital inputs, digital outputs and PTZ camera controls.
9	Power In	A plug to power the GV-Video Server.

GV-VS12

Front View

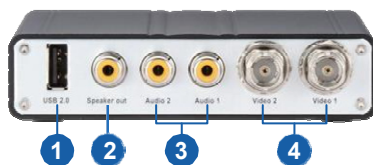

Rear View

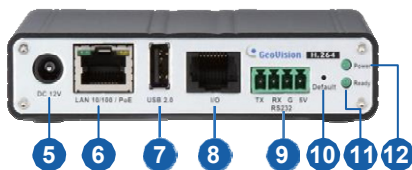

No.	Name	Function
1	USB Port	1 USB port for installing the portable storage device.
2	Speaker Output	A plug for the speaker device.
3	Audio Input	2 plugs for audio inputs.
4	Video Input	2 plugs for video inputs.
5	Power In	A plug to power the GV-Video Server.
6	Ethernet Port	A plug for inserting an Ethernet cable to build the network connection.
7	USB Port	1 USB port for installing the portable storage device.
8	I/O / PTZ Port	A port for digital input, relay output and PTZ camera control. Insert the I/O Cable with RJ-45 Connector to this port.
9	RS-232 Terminal Block	The connectors for GPS module control.
10	Default Button	It resets all configurations to their factory settings. See <i>7 Restoring to Default Settings</i> in the <i>Quick Start Guide</i> .
11	Ready LED	This LED is on, indicating the GV-Video Server is ready for connection.
12	Power LED	This LED is on, indicating the power is supplied.

GV-VS2420 / 2400

Front View

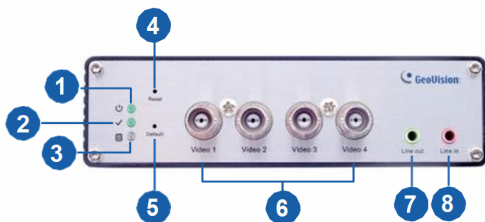

Rear View

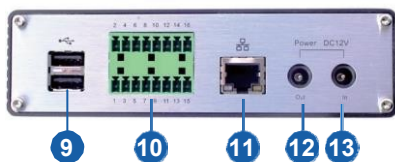

No.	Name	Function
1	Power LED	This LED is on, indicating the power is supplied.
2	Ready LED	This LED is on, indicating the GV-Video Server is ready for connection.
3	Disk Full/Fault LED	This LED is on, indicating the hard drive is full or faulty.
4	Reset	It reboots the GV-Video Server, and keeps all current configurations.
5	Default Button	It resets all configurations to their factory settings. See <i>7 Restoring to Default Settings</i> in the <i>Quick Start Guide</i> .
6	Video Input	4 plugs for video inputs.
7	Line Out	A plug for Video 1 speaker device.
8	Line In	A plug for Video 1 audio input.

9	USB Port	2 USB ports for installing portable storage devices.
10	Terminal Block	The connectors for digital inputs, relay outputs, and PTZ cameras. <i>See 8 Connecting Auxiliary Devices in the Quick Start Guide.</i>
11	Gigabit Ethernet Port	A plug for a 10/100/1000 Base-T Ethernet
12	Power Out	A plug to power the camera, by using the optional DC Male-to-Male Cable, directly through the GV-Video Server.
13	Power In	A plug for power input.

Note: When transmitting video signals over a long distance, it is highly recommended to use 5C-FB coaxial cables or above to minimize the degradation of image quality. The transmission distance should be within 300 m (984 ft).

GV-VS2401

Front View

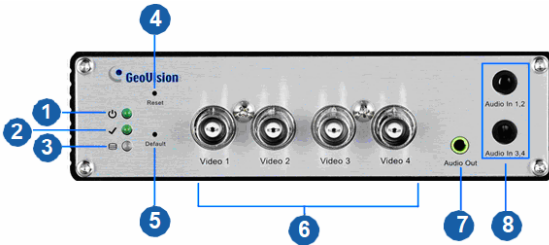

Rear View

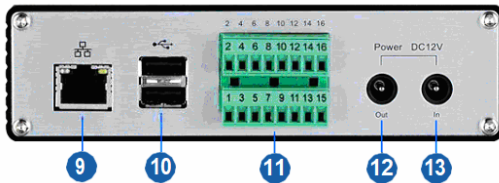

No.	Name	Function
1	Power LED	This LED is on, indicating the power is supplied.
2	Ready LED	This LED is on, indicating the GV-Video Server is ready for connection.
3	Disk Full/Fault LED	This LED is on, indicating the hard drive is full or faulty.
4	Reset	It reboots the GV-Video Server, and keeps all current configurations.
5	Default Button	It resets all configurations to their factory settings. See <i>7 Restoring to Default Settings</i> in the <i>Quick Start Guide</i> .
6	Video Input	4 plugs for video inputs.
7	Audio Out	A plug for the speaker device.
8	Audio In	Each plug is for 2 audio inputs.

9	Gigabit Ethernet Port	A plug for a 10/100/1000 Base-T Ethernet
10	USB Port	2 USB ports for installing portable storage devices.
11	Terminal Block	The connectors for digital inputs, relay outputs, and PTZ cameras. <i>See 8 Connecting Auxiliary Devices in the Quick Start Guide.</i>
12	Power Out	A plug to power the camera, by using the optional DC Male-to-Male Cable, directly through the GV-Video Server.
13	Power In	A plug for power input.

Note: When transmitting video signals over a long distance, it is highly recommended to use 5C-FB coaxial cables or above to minimize the degradation of image quality. The transmission distance should be within 300 m (984 ft).

GV-VS2820 / 2800

Front View

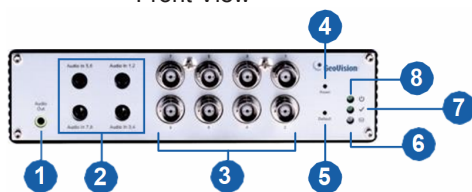

Rear View

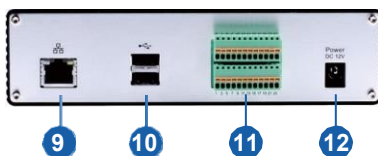

No.	Name	Function
1	Audio Out	A plug for the speaker device.
2	Audio In	4 plugs for max. 8 audio inputs.
3	Video Input	8 plugs for video inputs.
4	Reset	It reboots the GV-Video Server and keeps all current configurations.
5	Default Button	It resets all configurations to their factory settings. See <i>7 Restoring to Default Settings</i> in the <i>Quick Start Guide</i> .
6	Disk Full/Fault LED	This LED is on, indicating the hard drive is full or faulty.
7	Ready LED	This LED is on, indicating the GV-Video Server is ready for connection.
8	Power LED	This LED is on, indicating the power is supplied.
9	Gigabit Ethernet Port	A plug for a 10/100/1000 Base-T Ethernet
10	USB Port	2 USB ports for installing portable storage devices.
11	Terminal Block	The connectors for digital inputs, digital outputs, and PTZ cameras. See <i>8 Connecting Auxiliary Devices</i> in the <i>Quick Start Guide</i> .
12	Power In	A plug for power input.

Note: When transmitting video signals over a long distance, it is highly recommended to use 5C-FB coaxial cables or above to minimize the degradation of image quality. The transmission distance should be within 300 m (984 ft).

GV-VS21600

Front View

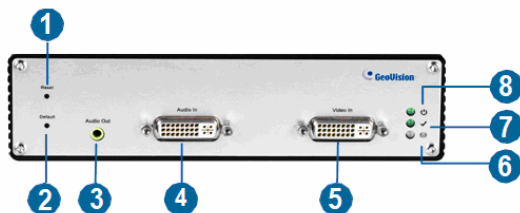

Rear View

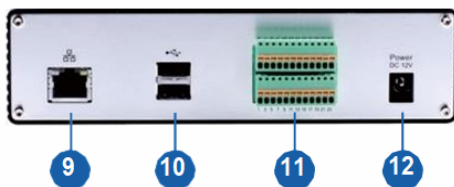

No.	Name	Function
1	Reset	It reboots the GV-Video Server and keeps all current configurations.
2	Default Button	It resets all configurations to their factory settings. See <i>7 Restoring to Default Settings</i> in the <i>Quick Start Guide</i> .
2	Audio Out	A plug for the speaker device.
3	Audio In	A DVI plug connected with 16 RCA ports for audio inputs.
4	Video Input	A DVI plug connected with 16 BNC ports for video inputs.
6	Disk Full/Fault LED	This LED is on, indicating the hard drive is full or faulty.
7	Ready LED	This LED is on, indicating the GV-Video Server is ready for connection.
8	Power LED	This LED is on, indicating the power is supplied.
9	Gigabit Ethernet Port	A plug for a 10/100/1000 Base-T Ethernet
10	USB Port	2 USB ports for installing portable storage devices.
11	Terminal Block	The connectors for digital inputs, digital outputs and PTZ cameras. See <i>8 Connecting Auxiliary Devices</i> in the <i>Quick Start Guide</i> .
12	Power In	A plug for power input.

Note: When transmitting video signals over a long distance, it is highly recommended to use 5C-FB coaxial cables or above to minimize the degradation of image quality. The transmission distance should be within 300 m (984 ft).

3 Installing on a Network

Here we use **GV-VS04H** as an example to demonstrate the basic connections.

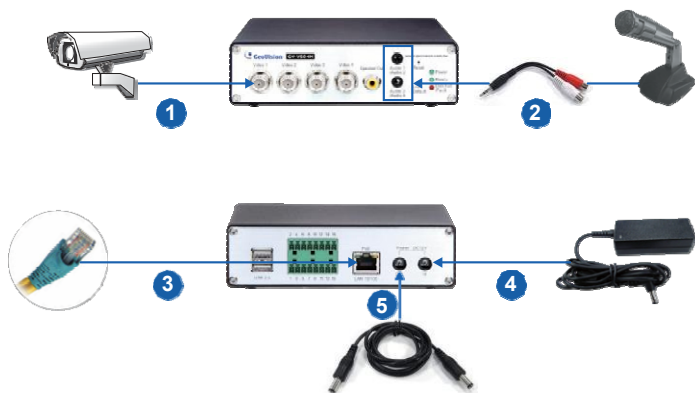

1. Connect your camera's video output to the BNC video input.
2. Connect the microphone to the RCA audio input using the 3.5 mm Stereo to RCA Cable.
3. Connect the hub or switch on the LAN to the unit's 10/100 Mbps port.
4. Connect power using one of the following methods:
 - Use the supplied power adapter to connect to power.
 - Use the Power over Ethernet (PoE) function to provide power over the network cable.
5. Optionally connect the DC Male-to-Male Cable to power the camera through the GV-Video Server.
6. Wait until both Power and Ready LEDs are on and then you can access its Web interface. See *4. Accessing the GV-Video Server* later in the *Quick Start Guide*.

Note:

1. GV-VS11 / 14 / 2420 / 2400 / 2401 / 2800 / 2820 / 21600 do not support PoE function.
2. For the users of other models, see *Options* in *1 Introduction*.
3. GV-Video Server cannot work with microphones requiring power from the unit. Use the microphone that has external power supply.
4. When PoE is applied, you cannot power the camera through the GV- Video Server.

System Requirements

To access the Web interface of the GV-Video Server, ensure your PC is in good network connection and use one of the following Web browsers:

For GV-VS04H / 11 / 12 / 14

- Microsoft Internet Explorer 7.x or later

For GV-VS2420 / 2400 / 2401 / 2800 / 2820 / 21600

- Microsoft Internet Explorer 8.x or later
- Google Chrome
- Mozilla Firefox
- Safari
- Microsoft Edge

Note:

1. For the users of **Internet Explorer 8 or later**, additional settings are required. For details, see *Appendix A* in *GV-Video Server User's Manual* on the GeoVision download page:
<http://www.geovision.com.tw/download/product/>.
2. **Internet Explorer 10** is only supported by GV-VS11 version 1.05, GV-VS12 version 1.09 and GV-VS14 version 1.03.
3. For users of non-IE browsers using GV-VS2420 / 2400 / 2401 / 2800 / 2820 / 21600, download **GV-Web Viewer** to access full functioning user interface. For details, see *3.1 Accessing Your Surveillance Images* in *GV-Video Server User's Manual* from the GeoVision download page:
<http://www.geovision.com.tw/download/product/>.

Checking the IP Address and Logging In

By default, the IP address of your GV-Video Sever is assigned by the DHCP server unless your router does not support DHCP. In this case, the default IP address will be 192.168.0.10. Follow the steps below to look up the IP address and access the Web interface.

1. Install the GV-IP Device Utility program from GeoVision download page: <http://www.geovision.com.tw/download/product/>.

Note: The PC installed with **GV-IP Device Utility** must be under the same LAN as the GV-Video Server you wish to configure.

2. On the GV-IP Utility window, click the  button to search for the IP devices connected in the same LAN. Click the Name or Mac Address column to sort.

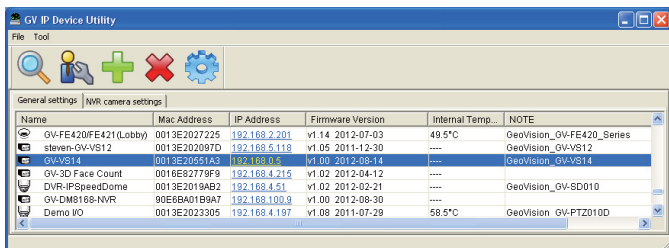

Name	Mac Address	IP Address	Firmware Version	Internal Temp...	NOTE
GV-FE420FE421(Lobby)	0013E2027225	192.168.2.201	v1.14 2012-07-03	49.5°C	GeoVision_GV-FE420_Series
steven-GV-VS12	0013E202097D	192.168.5.118	v1.05 2011-12-30	----	GeoVision_GV-VS12
GV-VS14	001E20051A3	192.168.0.4	v1.00 2012-08-14	----	GeoVision_GV-VS14
GV-3D Face Count	0016E82779F9	192.168.4.215	v1.02 2012-04-12	----	
DVR-IPSpeedDome	0013E2019482	192.168.4.51	v1.02 2012-02-21	----	GeoVision_GV-SD010
GV-DM8168-1NVR	90E6B401B9A7	192.168.100.9	v1.00 2012-08-30	----	
Demo I/O	0013E2023305	192.168.4.197	v1.08 2011-07-28	58.5°C	GeoVision_GV-PTZ010D

3. Find the GV-Video Server with its Mac Address to see the IP address.
4. To login, type the IP address in your Web browser. A dialog box appears.
5. Type the default username and password **admin**.
6. Click **Apply** to access the Web interface.
7. When accessing the GV-Video Server for the first time, you must set your browser to allow a one-time installation of GeoVision's ActiveX component onto your computer.

Note: If your router does not support DHCP, the default IP address will be **192.168.0.10**. In this case, it is strongly suggested to modify the IP address to avoid IP address conflict with other GeoVision IP device on the same LAN. For details, see *2.3 Changing the IP Address, GV-Video Server User's Manual*.

5 The Web Interface

Live View

In this section you can see and configure the default camera view.

Live View Configuration

17:55:53 Play

Information

- Version
v1.02 2010-07-26
- Local time
2003/12/03 17:56:06
- Host time
2010/11/05 17:55:53
- Online count
3
- OCX Registration Path
C:\WINDOWS\GeoOCX\WebC...

1 2 3 4 5 6 7 8 9 10 11 12

No.	Name	Function
1	Play	Plays live video.
2	Stop	Stops playing video.
3	Microphone	Talks to the surveillance area from the local computer.
4	Speaker	Listens to the audio around the camera.
5	Snapshot	Takes a snapshot of live video.
6	File Save	Records live video to the local computer.
7	Full Screen	Switches to full screen view. Right-click the image to have these options: Snapshot, PIP, PAP, Zoom In and Zoom Out .
8	Control Panel	Displays the camera information, video settings, audio data rate, I/O device status, images captured upon alarm and GPS location of the camera.
9	I/O Control	Starts I/O Control Panel or Visual Automation .
10	PTZ Control	Starts PTZ Control Panel and Visual PTZ .
11	Change Camera	Sets the desired camera for display.
12	Show System Menu	Brings up these functions: Alarm Notify, Video and Audio Configuration, Remote Config, Show Camera Name and Image Enhance .

For detailed operations, see *Accessing the GV-Video Server, Chapter 3, GV-Video Server User's Manual*.

6 Upgrading System Firmware

GeoVision will periodically release the updated firmware on the website. To load the new firmware into the GV-Video Server, read the important notes below and follow the instructions.

Important:

1. While the firmware is being updated,
 - A) the power supply must not be interrupted, and
 - B) do not unplug the Ethernet cable if the cable is the source of power supply (Power over Ethernet or PoE supported).
2. Do not turn the power off within 10 minutes after the firmware is updated.
3. If you use the IP Device Utility for firmware upgrade, the computer used to upgrade firmware must be under the same network as the GV-Video Server.

1. In the Live View window, click the **Show System Menu** button and select **Remote Config**. This dialog box appears.

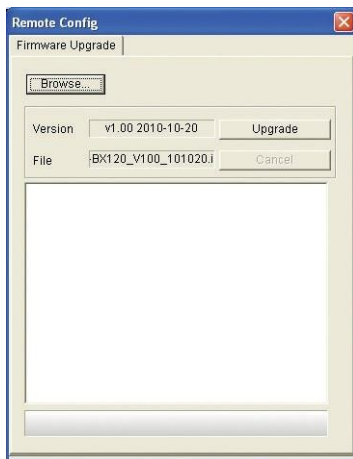

2. Click the **Browse** button to locate the firmware file (.img) saved at your local computer.
3. Click the **Upgrade** button to start the upgrade.

WARNING: The interruption of power supply during updating causes not only update failures but also damages to your GV-Video Server. In this case, please contact our sales representatives and send your device back to GeoVision for repair.

For details on upgrading system firmware, see *Advanced Applications, Chapter 6, GV-Video Server User's Manual*.

7 Restoring to Default Settings

You can restore the camera to factory default settings using the Web interface or directly on the GV-Video Server.

Using the Web Interface:

1. On the left menu of Web interface, select **Management** and select **Tools**. The **Additional Tools** dialog appears.
2. Click the **Load Default** button in the System Settings section.

The screenshot shows the 'Additional Tools' configuration page in the GeoVision web interface. The left sidebar contains a navigation menu with 'Management' and 'Tools' highlighted with red boxes. The main content area is titled 'Additional Tools' and contains several sections:

- Host Settings:** A text input field for 'Host Name' containing 'GV-VS11' and an 'Apply' button below it.
- Auto Reboot Setup:** An 'Enable' checkbox (unchecked), a 'Day Interval' dropdown set to '1' days, and a 'RebootTime' dropdown set to '00:00'. An 'Apply' button is below.
- Repair Record Database:** An 'Apply' button.
- Repair Database Status:** A label 'Unknown'.
- Firmware Update:** A text input field containing 'v1.00.2011-09-16'.
- System Settings:** A label 'Restore to factory default settings:' followed by a 'Load Default' button highlighted with a red box.
- Reboot:** A label 'Do you wish to reboot now?' followed by a 'Reboot' button.

Directly on the GV-Video Server:

GV-VS04H / 14



1. Press and then release the **Reset** button immediately.
2. Press and hold the **Load Default** button until all 3 LEDs (Power, Ready and Disk Full/Fault) are on. This may take about 30seconds.
3. Release the **Load Default** button. The process of loading default values is complete, and the GV-Video Server starts rebooting itself with all 3 LEDs turned off.
4. Wait until the Power and Ready LEDs turn on again. After this, all the settings are returned to default values.

GV-VS11



GV-VS12



1. Unplug and plug the power cable to start.
2. Press and hold the **Default** button until the Ready LED blinks. This may take about 30 seconds. The Ready LED will blink twice.
3. Release the **Default** button. The process of loading default values is complete, and the GV-Video Server starts rebooting itself with the 2 LEDs turned off.
4. Wait until the Power and Ready LEDs turn on again. After this, all the settings are returned to default values.

GV-VS2420 / 2400



GV-VS2401



GV-VS2820 / 2800



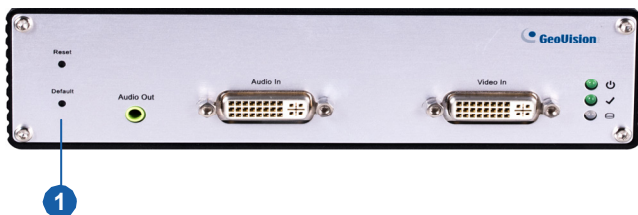

1. Press and hold the **Default** button until the Ready LED blinks. This may take up to 10 seconds. The Ready LED will blink twice.
2. Release the **Default** button. The process of loading default values is complete, and the GV-Video Server starts rebooting itself with the Ready LED turned off.
3. Wait until the Ready LED turns on again. After this all the settings are returned to default values

Note: Before the **Ready LED** is on again, do not unplug the power cable; otherwise the loading of default values will fail.

GV-VS04H / 14 / 2420 / 2400 / 2401 / 2820 / 2800 / 21600**GV-VS04H / 14 / 2420 / 2400 / 2401**

The 16-pin terminal block, located on the rear panel, provides interfaces for four digital inputs, four relay outputs, an RS-485 interface, a Wiegand interface, a GPS interface or auxiliary power. The terminal block can be used to develop applications for motion detection, event alerts via E-mail and FTP, center monitoring by Center V2 and Vital Sign Monitor, PTZ control or Wiegand-interface card reader, and a variety of other functions.

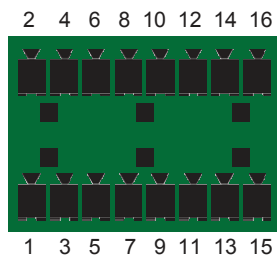

Pin Assignment

The table below lists the pin assignment for the terminal block.

GV-VS04H / 14

Pin	Function	Pin	Function
1	Relay Output 1	9	DC 5V Out for GV-Relay Module, or GPS Module
2	Digital Input 1	10	Ground, or GPS Ground
3	Relay Output 2	11	RS 485+
4	Digital Input 2	12	Wiegand D0, or GPS RX
5	Relay Output 3	13	RS 485-
6	Digital Input 3	14	Wiegand D1, or GPS TX
7	Relay Output 4	15	Ground
8	Digital Input 4	16	DC 12V Out for Wiegand Card Reader

Note: To connect the GPS module, use Pin 9 for power supply, Pin 10 for ground, Pin 12 for GPS RX and Pin 14 for GPS TX.

GV-VS2420 / 2400 / 2401

Pin	Function	Pin	Function
1	Digital Output 1	9	DC 5V Out for GV-Relay Module
2	Digital Input 1	10	Ground
3	Digital Output 2	11	RS 485+
4	Digital Input 2	12	N/A
5	Digital Output 3	13	RS 485-
6	Digital Input 3	14	N/A
7	Digital Output 4	15	Ground
8	Digital Input 4	16	DC 12V Out

GV-VS2820 / 2800 / 21600

The 24-pin terminal block, located on the rear panel, provides interfaces for eight digital inputs, eight digital outputs, an RS-485 interface and auxiliary power. The terminal block can be used to develop applications for motion detection, event alerts via E-mail and FTP, center monitoring by Center V2 and Vital Sign Monitor, PTZ control and a variety of other functions.

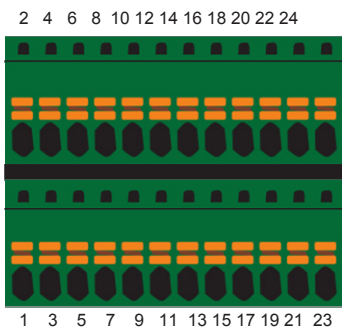

GV-VS2820 / 2800 / 21600

Pin	Function	Pin	Function
1	Digital Output 1	13	Digital Output 7
2	Digital Input 1	14	Digital Input 7
3	Digital Output 2	15	Digital Output 8
4	Digital Input 2	16	Digital Input 8
5	Digital Output 3	17	Ground
6	Digital Input 3	18	Ground
7	Digital Output 4	19	DC 5V Out for GV-Relay Module
8	Digital Input 4	20	RS 485+
9	Digital Output 5	21	Ground
10	Digital Input 5	22	RS 485-
11	Digital Output 6	23	DC 12V Out
12	Digital Input 6	24	Ground

GV-VS11

The terminal block on the rear panel of GV-VS11 provides one digital input and output, an RS-485 interface and auxiliary power.



Pin Assignment

The table below lists the pin assignment for the terminal block.

Pin	Function
RS-485-	RS-485-
RS-485+	RS-485+
5V	DC 5V Out
DI	Digital Input
DO	Digital Output
G	Ground

GV-VS12

GV-VS12 provides **I/O Cable with RJ-45 Connector** for extensible connection to I/O devices and PTZ cameras. A RJ-45 connector and a bundle of shielded wires are on each end of the cable.

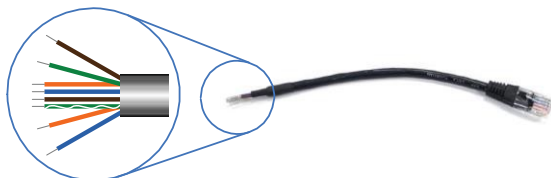

Pin Assignment

The table below lists the pin assignment for the shielded wires of the I/O Cable with RJ-45 Connector.

Pin	Wire	Function
1	Brown	Digital Out 1
2	White with Brown Stripe	Digital Out 2
3	White with Green Stripe	Ground
4	White with Blue Stripe	Digital In 1
5	Blue	Digital In 2
6	Green	Ground
7	Orange	RS-485 -
8	White with Orange Stripe	RS-485 +

RS-232 Terminal Block

The RS-232 terminal block on GV-VS12 is mainly used for connecting to a GPS module.

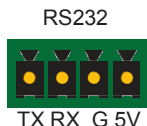

Pin	Function
TX	GPS RX (Receive)
RX	GPS TX (Transmit)
G	Ground
5V	DC 5V Out

Note: To ensure the connection to the GV-VS12, the GPS RX must be connected to the TX pin, and the GPS TX must be connected to the RX pin.

For details, see *Auxiliary Device Connectors, Chapter 9, GV-Video Server User's Manual* on the GeoVision download page:

<http://www.geovision.com.tw/download/product/>.



9F, No. 246, Sec. 1, Neihu Rd., Neihu District, Taipei, Taiwan

Tel: +886-2-8797-8376 Fax: +886-2-8797-8335

support@geovision.com.tw

<http://www.geovision.com.tw>